

CHIAYO

Operation manual

COACH 400

Personal Wireless PA System



9001:2015

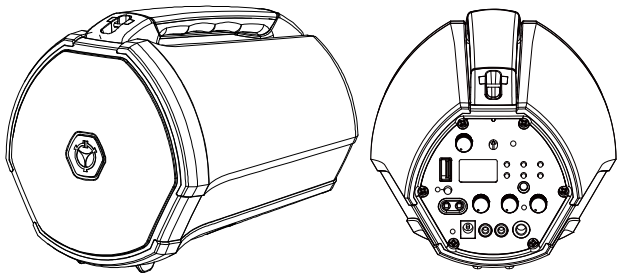

Important safety instructions

- Read all of the instructions before the product is operated.
- Keep these instructions well for future reference.
- Follow all of the warnings and instructions when installing, setting up and using the product.
- Only clean the product when it is not connected to the power supply system. Clean only with a dry cloth.
- Keep ventilation openings unblocked and follow with the manufacturer's instructions for installation.
- Do not immerse product in any liquid or expose to heat or moisture
- Keep the complete polarized or grounding type plug without any modification. A polarized plug has two blades with one wider than the other. A grounding type plug has two blades and a third grounding prong. The wider blade or the third prong are provided for your safety. If the provided plug does not fit into your outlet, consult an electrician for replacement of the obsolete outlet.
- Power supply cords should be well routed to prevent from being walked on or pinched by items placed upon or against them, particularly at plugs, convenience receptacles, and the point where they exit from the product.
- Use only manufacturer authorized or recommended accessories.
- Use only with a cart, stand, tripod or accessories specified or provided by Chiayo. Be careful when using a cart to avoid injury from tip-over.
- Unplug the product during an electrical storm or when unused for long periods of time.
- Never disassemble, modify or service the product. Any unauthorized modifications may result in personal injury and/or product failure. Additionally, your warranty will be void.
- Please read and follow the instructions in this manual thoroughly to obtain optimum results from this unit. We also recommend that you keep this manual handy for future reference.

INDEX

1. Instruction	3
1-1. In the box	3
1-2. Optional related products	3
1-3. Parts and functions	4
1-4. Charging the battery	4
1-5. Connection with external audio sources.....	5
2. Settings and Operations	6
2-1. Using the wired microphone (MIC IN)	6
2-2. Using the wireless receiver	7
2-3. Music audio input (AUX IN)- Smart phone / tablet / MP3 player	8
2-4. Using the MP3 player & recorder.....	9
2-4-1. <i>Parts and functions</i>	9
2-4-2. <i>Operating functions on the panel and the remote</i>	9
2-5. Operating BLUETOOTH receiver (BT).....	11
2-6. TONE for WIRED and WIRELESS MICROPHONE and MUSIC	12
3. FAQ & useful operation tips.....	13
4. Maintenance-free Lead-acid and Lithium batteries	15

1. Instruction

Congratulations and thank you for purchasing this personal wireless PA system. To ensure a trouble-free operation, please read the manual thoroughly to fully understand its controls and functions.

This portable amplifier is divided into 2 major sections:

1. Control unit compartment on the rear panel
2. Battery compartment on the bottom

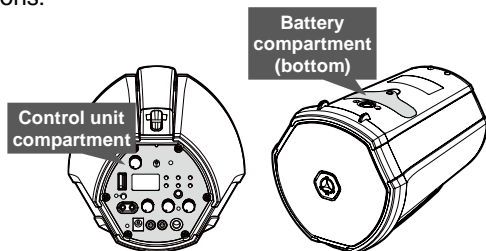

1-1. In the box

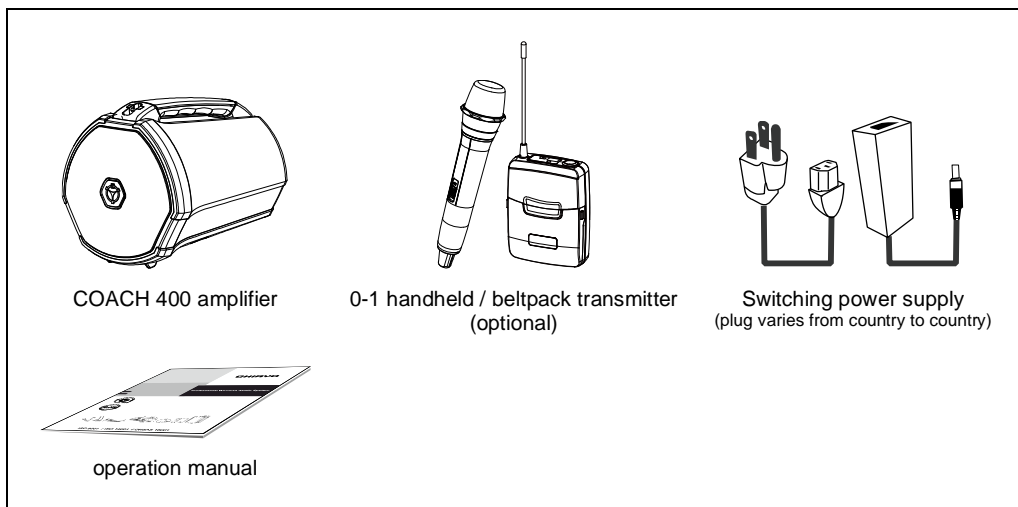

1-2. Optional related products

■ **Transmitters (For more information about transmitter, please refer to its user manual)**

SQ-5116	Handheld microphone	SM-2016	Belt-pack transmitter
----------------	---------------------	----------------	-----------------------

■ **Accessories**

ST-30	Tripod stand: standard	SB-41A	Carrying bag
DC-20	Dust-proof cover: black or grey	DM-series	Wired microphone, please refer to CHIAYO website .

1-3. Parts and functions

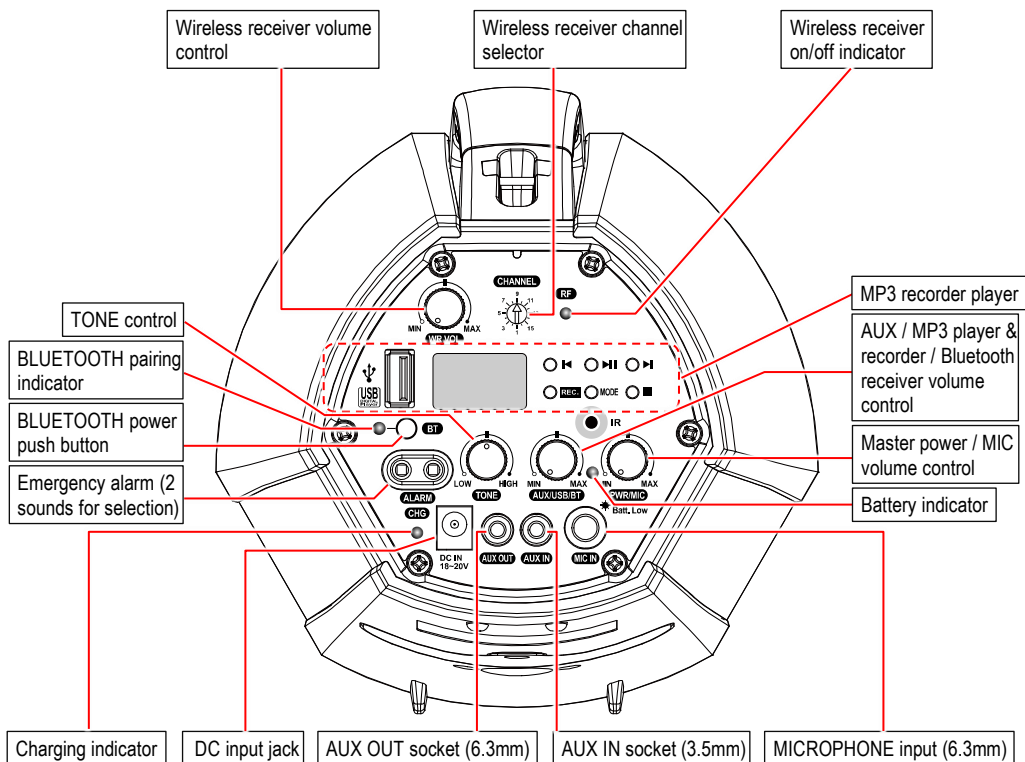

1-4. Charging the battery

If the battery indicator turns solid RED, the battery might not be sustainable for long operation and needs to be charged.

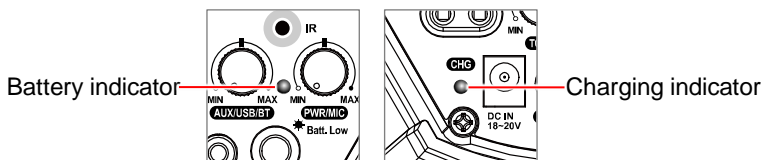

Battery indicator	Condition	Charging indicator	Condition
Solid RED	Low battery	Solid RED	During recharging
Solid GREEN	Normal voltage	Solid GREEN	Fully charged

1-5. Connection with external audio sources

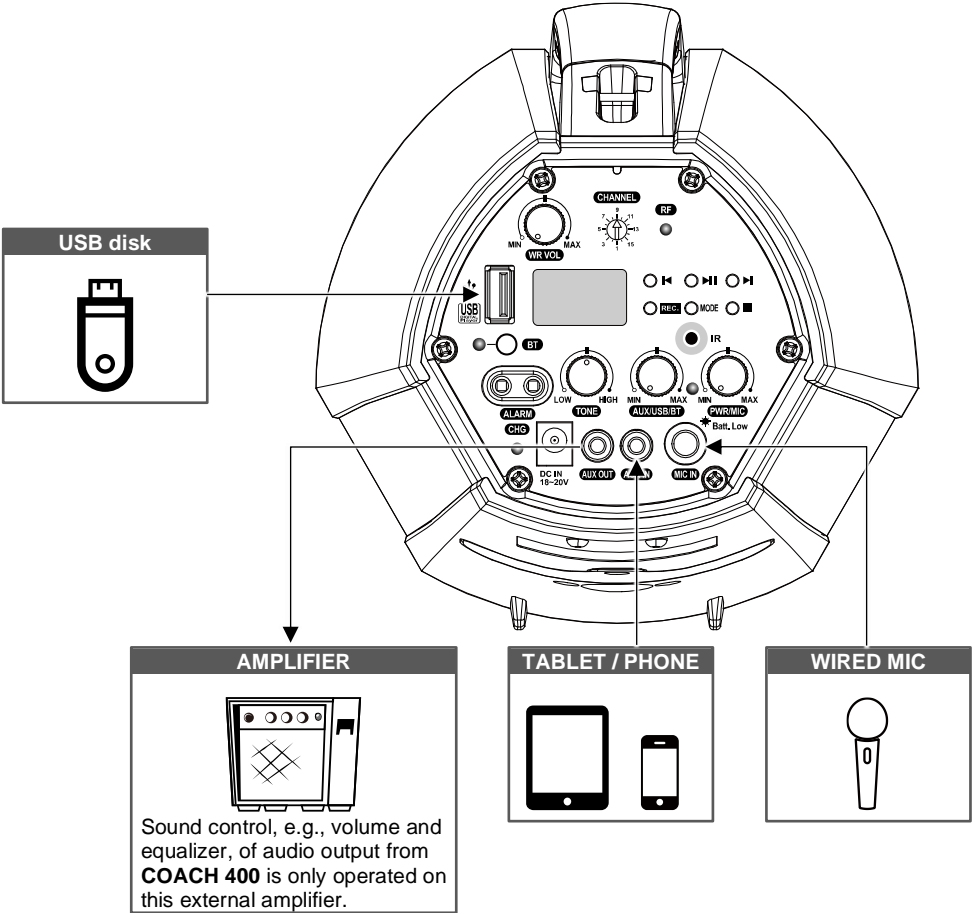

2. Settings and Operations

2-1. Using the wired microphone (MIC IN)

- 1 Plug a wired microphone with a 6.3mm plug to **MIC IN**.

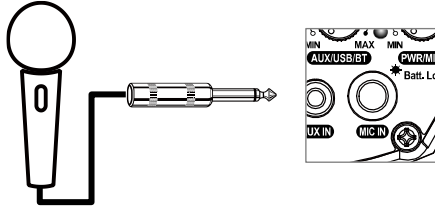

- 2 Turn ON master POWER and then adjust **PWR/MIC** volume control to desired level.

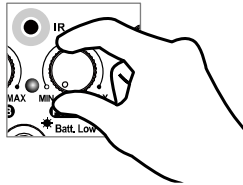

- 3 LOW-HIGH TONE can be adjusted. (refer to P.12)

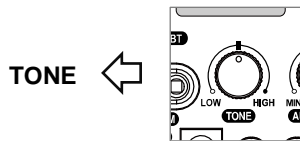

2-2. Using the wireless receiver

- 1 Turn ON master POWER and **WR VOL** in order, the receiver's power indicator will glow RED. After turning ON the transmitter, this LED will turn GREEN.

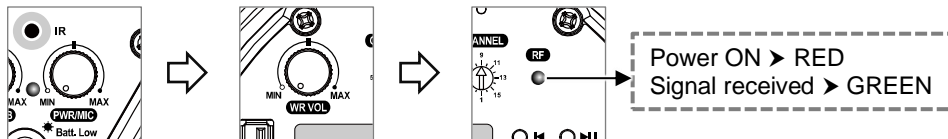

- 2 Adjust **WR VOL** volume control to desired level.

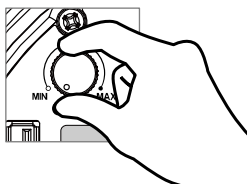

- 3 LOW-HIGH TONE can be adjusted. (refer to P.12)

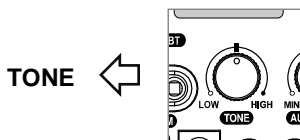

2-3. Music audio input (AUX IN)- Smart phone / tablet / MP3 player

- 1 Connect your device to the 3.5mm jack of **AUX IN** with a 3.5mm **3-pole stereo** audio cable.

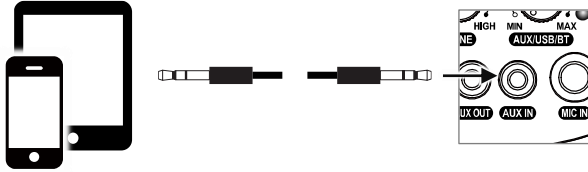

- 2 Turn ON master POWER and then adjust **AUX/USB/BT** volume control to a desired level.

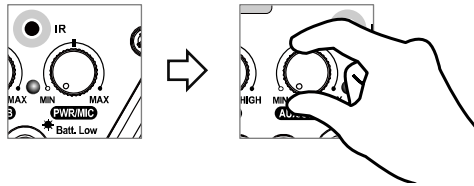

- 3 **LOW-HIGH TONE** can be adjusted. (refer to P.12)

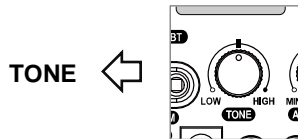

2-4. Using the MP3 player & recorder

2-4-1. Parts and functions

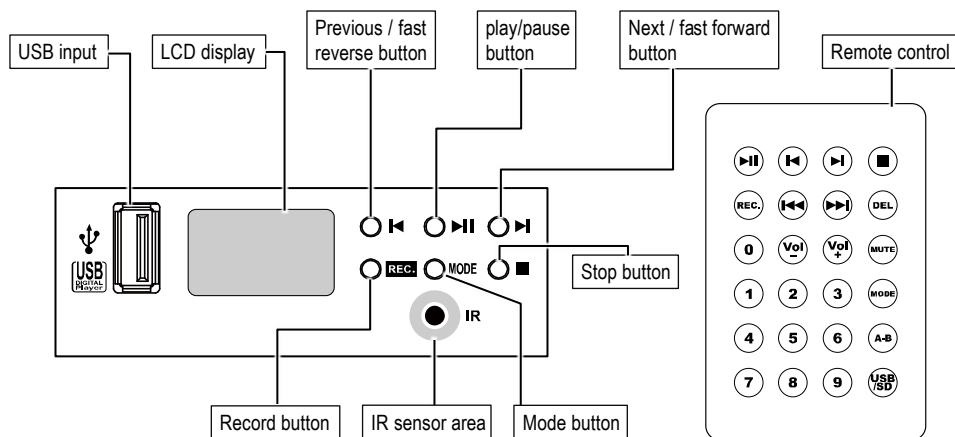

2-4-2. Operating functions on the panel and the remote

Operating function	On the panel	On the remote
Play/pause	Press	Press
Record	Press to record and or to stop.	Press to record and or to stop.
Skip forward	Press	Press
Fast forward	Press and hold	Press and hold
Skip backward	Press	Press
Fast backward	Press and hold	Press and hold
Next folder	-	Press
Previous folder	-	Press
Track select (#0-9)	-	input track number, then press
Repeat mode switch (ALL/SINGLE/FOLDER)	Press	Press
Volume control	-	Press or
A-B section play	-	Press to start, again to play section and again to stop
Delete tracks	-	Press to delete track and again to confirm your delete
Mute	-	press to mute/recover

- 1** Turn ON master POWER and **AUX/USB/BT** in order.

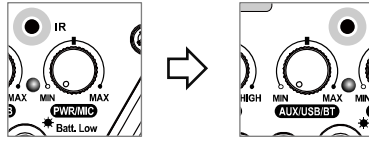

- 2** Plug the USB and the music will play automatically. To dispatch the USB, please turn off the player first.

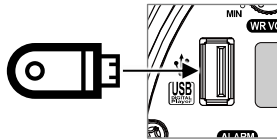

- 3** Adjust **AUX/USB/BT** volume control to desired level.

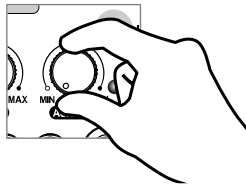

- 4** LOW-HIGH TONE can be adjusted. (refer to P.12)

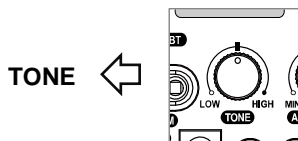

Note:

- Supports FAT and FAT32 file systems only.
- Supports MP3, WAV and WMA music formats only
- Record track format: MP3; Bit rate: 128kbps; Sampling frequency: 44kHz
- Recordable only when USB is detected.
- Record files will be stored in the **RECORD** folder of USB.
- The files will be named as **FILE_001, FILE_002, FILE_003...**etc.
- The name of a deleted track won't be applied to its next one.
- Recordable until **FILE_999** appears with LCD displaying **Num Full**.
- LCD displays **USB FULL** when insufficient memory left.
- Don't remove the USB during the recording process in case the interrupted track might be damaged.

2-5. Operating BLUETOOTH receiver (BT)

1 Turn ON master POWER and **AUX/USB/BT** in order.

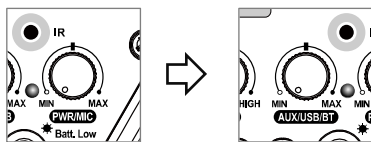

2 Press the **BT** button 3 seconds to turn on the BLUETOOTH receiver. The pairing indicator will flash green and it's ready to pair.

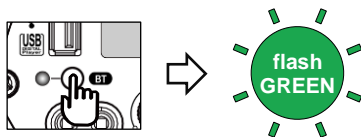

3 Activate BLUETOOTH on your device (phone, tablet, PC., etc) and pair with external BLUETOOTH device named "**BT AUDIO**". After successful linking, the pairing indicator will be solid green and you can play your music on **COACH 400**.

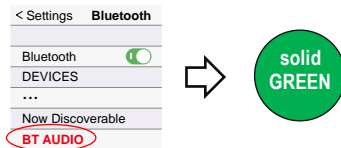

4 Adjust **AUX/USB/BT** volume control to a desired level.

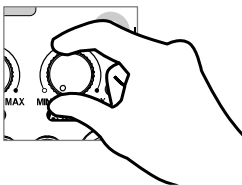

5 LOW-HIGH TONE can be adjusted. (refer to P.12)

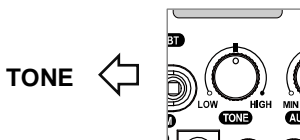

Important

- The BLUETOOTH automatically turns off after no pairing for 5 minutes.
- Press **BT** button for disconnection and getting ready for new pairing.
- The BLUETOOTH can memorize and automatically connect to last-paired device.

2-6. TONE for WIRED and WIRELESS MICROPHONE and MUSIC

TONE adjustment is actually used to increase or reduce the high/low frequency component of the speaker's restored sound. It is so-called raising or attenuating TREBLE (HIGH) / BASS (LOW) via frequency-specific volume knob to improve human voices or make musical instruments' sound more prominent. According to the scale mark on the panel, clockwise adjustment is to increase / boost high frequency, opposite to increase / boost low frequency. Adjust the level of high frequency (HIGH) and low frequency (LOW). All signals have been balanced by the high and low sounds after entering the amplifier so it is not necessary to adjust the TONE during the output to the speaker. It is recommended to maintain the position of TONE at just 12 o'clock.

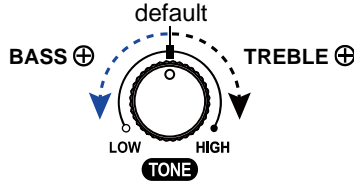

DIRECTION	HIGH (CLOCKWISE)	LOW (COUNTERCLOCKWISE)
FUNCTION	increase the high frequency component of the sound to boost treble	increase the low frequency component of the sound to boost bass
RANGE	-12 dB ~ +12 dB	
DEFAULT	12 o'clock	

3. FAQ & useful operation tips

1 How to adjust the best volume?

Gradually adjust the volume of audio inputs from minimum to an appropriate level. Then adjust volume according to the surrounding environment and the required sound (microphone, MP3 ... etc.).

2 Is it possible to play music storing on external devices via wireless amplifier?

Yes. COACH 400 wireless amplifier has an auxiliary audio input (AUX IN) for connection with external devices such as notebook, mobile phones or tablets. The built-in MP3 recorder has remote control and offers more versatile functionality.

3 Is it possible to record the sound of Microphone or external devices when using COACH 400?

Yes. The built-in MP3 recorder on **COACH 400** has the recording function.

4 How to avoid or reduce feedback?

■ Do not stand in front of the speaker when using the microphone.

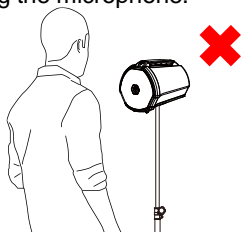

■ Do not point the wireless microphone towards the speaker.

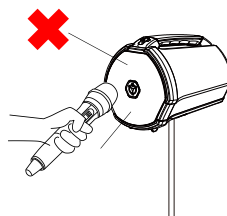

■ Use the microphone behind the speaker as possible.

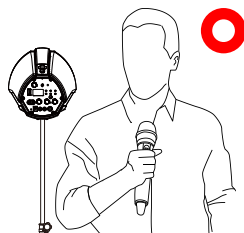

■ Locate the wireless amplifier between the speaker and the audience with the speaker facing the crowd. Place the wireless amplifier on a tripod stand and above the head of audience (about 180cm).

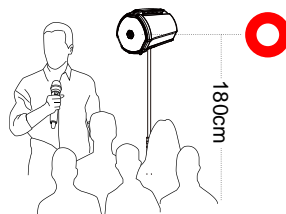

■ Turn down the volume if necessary.

5 Does a wireless amplifier need to be installed with a tripod? What is the ideal height for Amplifier above the ground?

Higher position of a wireless PA will be helpful for signal reception. It can be mounted on the tripod and above the ear or head of the audience. If the tripod is not allowed on site, you can also raise it on a table or a flat object while the amplifier leaves the ground by 1 meter or more.

6 Will wireless amplifier automatically power off once it is fully charged? Do I need to unplug the power cord?

Yes. Since all CHIAYO amplifiers have an overcharge protection circuit that automatically power off at full charge and prevent damage to the system. However, please unplug the power cord after fully charging to ensure the safety.

7 How to charge and maintain the battery of wireless amplifier?

After plugging the power cable of the wireless amplifier into a standard outlet, the charging LED will glow or flash indicative of charging status. The wireless amplifier can be charged whether power on or off.

The amplifier's battery has no memory effect and can be charged any time. It is suggested to charge the battery right after usage to make the battery life longer. If not to use it for a long period, please charge the battery at least every three months for lead-acid batteries and six months for lithium batteries.

The battery life is limited and affected by the environment, charging method and battery efficiency.

8 Is it possible that COACH 400 can work as amplifier only? Can I use only one or more microphones? How many wireless microphones can be used at most?

COACH 400 can work as amplifier only. Only one microphone can be used on the amplifier.

4. Maintenance-free Lead-acid and Lithium batteries

Cautions when using the battery

1. Lead-acid batteries/lithium batteries have no memory effect. Please charge them up immediately after each use, no matter how much power they left. If the battery is not charged for a long time, it may cause the battery to be over-discharged and damaged, making it impossible to charge normally.
2. Usage temperature can't be lower than -10°C nor higher than 50°C.
3. It's strictly forbidden to let the battery contact with any liquid. Do not immerse the battery in water or get it wet. After the battery is exposed to water, a decomposition reaction may occur, which may cause battery self-ignition or even cause an explosion.
4. It is forbidden to use the battery when it has swelled, leaked, or the packaging is damaged.
5. It is forbidden to disassemble the battery in any way or pierce the battery with a sharp object, so as not to cause the battery to catch fire or even cause an explosion.
6. The liquid inside the battery is highly corrosive. If it leaks, please do not touch it. If the internal liquid splashes on human skin or eyes, please immediately rinse with clean water for at least 15 minutes before seeking medical attention.
7. It is forbidden to use wires or other metal objects to short-circuit the positive and negative electrodes of the battery.

Cautions when charging the battery

1. Lead-acid batteries/lithium batteries have no memory effect. Please charge them up immediately after each use, no matter how much power they left. If the battery is not charged for a long time, it may cause the battery to be over-discharged and damaged, making it impossible to charge normally.
2. Please use the power supply specified by CHIAYO for charging.
3. The CHIAYO amplifier has a protection circuit to prevent overcharging. To ensure safety, the charging time should not exceed 12 hours. Please disconnect the power supply when fully charged.
4. Charging temperature can't be lower than 0°C nor higher than 40°C.
5. When charging, please place it on the hard ground, such as cement, and there should be no flammable or combustible materials around. Please pay attention to the charging process to prevent accidents.
6. It will automatically stop charging when fully charged. After the battery is fully charged, it is recommended to disconnect the amplifier from the power supply.
7. When the power supply is not disconnected and the amplifier is not in use, if the battery is fully charged and then recharged again soon after, it means that the battery is aging and cannot store power. Please replace the battery to ensure enough time for operation.

Cautions when storing the battery

1. Lead-acid batteries/lithium batteries have no memory effect. Please charge them up immediately after each use, no matter how much power they left. If the battery is not charged for a long time, it may cause the battery to be over-discharged and damaged, making it impossible to charge normally.
2. Lithium batteries will automatically discharge in storage. If they are not charged for a long time, they will over discharge that causes a decrease in capacity and damage to the batteries that can no longer be charged normally. It should be fully charged at least once every 6 months.
3. Lead-acid batteries will automatically discharge in storage. If they are not charged for a long time, they will over discharge that causes a decrease in capacity and damage to the batteries that can no longer be charged normally. It should be fully charged at least once every 3 months.
4. Storage temperature can't be lower than -10°C nor higher than 40°C.

Disposing the battery

Be sure to completely discharge the battery before placing it in the designated battery recycling bin. Batteries contains dangerous chemicals. When disposing of old batteries, be sure to follow the local battery recycling and disposal regulations, and it is strictly forbidden to put them in a trash can.

CHIAYO ELECTRONICS CO., LTD.

Http://www.chiayo.com.tw | Email: sales@chiayo.com.tw
Office: 30, Lane 27, Section 4, Jen-Ai Road, Taipei 10685, Taiwan
Tel: 886-2-27415741 | Fax: 886-2-27525242
Factory: 88, Chung-Hsiao Street 2, Chiayi 60080, Taiwan
Tel: 886-5-2711000 | Fax: 886-5-5767611

