

# CHIAYO

## Operation manual

### NDR-3110

UHF 1/2 19" Single-Channel Auto Sync  
Diversity Receiver



9001:2015

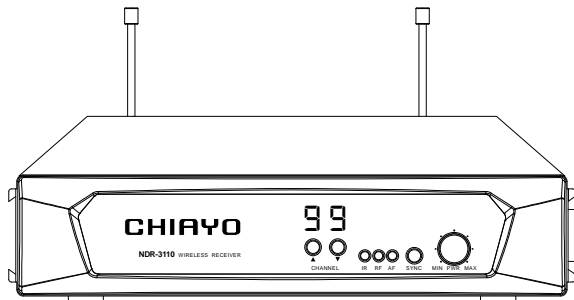

## NDR-3110 UHF 1/2 19" Single-Channel Auto Sync Diversity Receiver

Thank you for choosing this wireless microphone system! For more details, please take a few moments to read this operating manual to have a thorough understanding of the function and operation of both transmitter and receiver.

### In the box

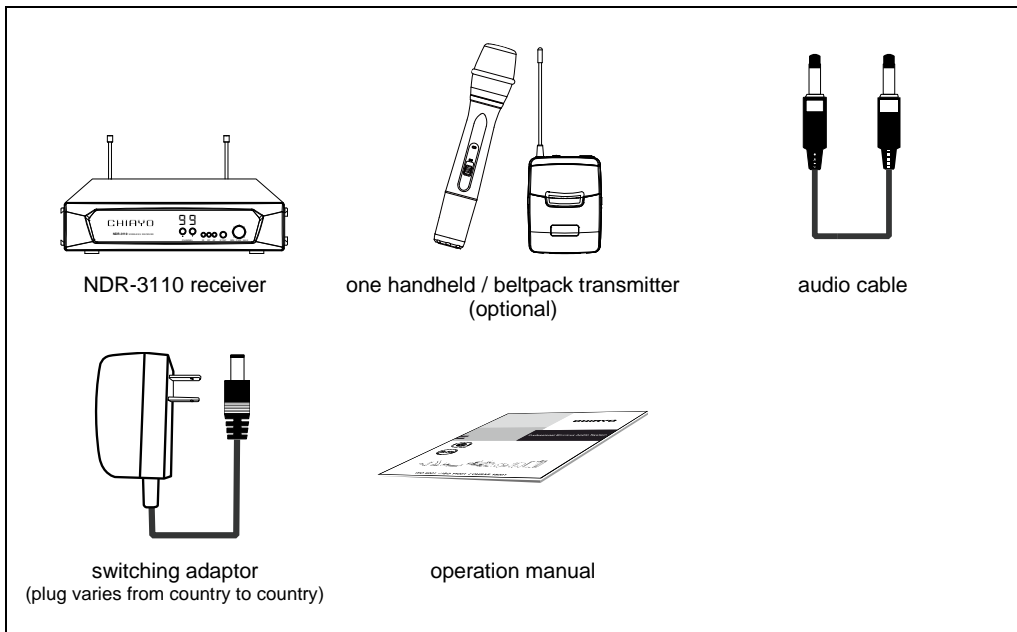

\*\* Remark: The above specifications are subject to change without prior notice.

### Important

1. Please make sure that the output DC voltage range of the switching power covers that specified by the receiver before turning it on.
2. The RF indicator will glow to denote RF signal received after turning on the transmitter.
3. The receiver and transmitter must be the same frequency.
4. While using the transmitter, the audio signal indicator will glow to denote audio signal received.

Parts and functions

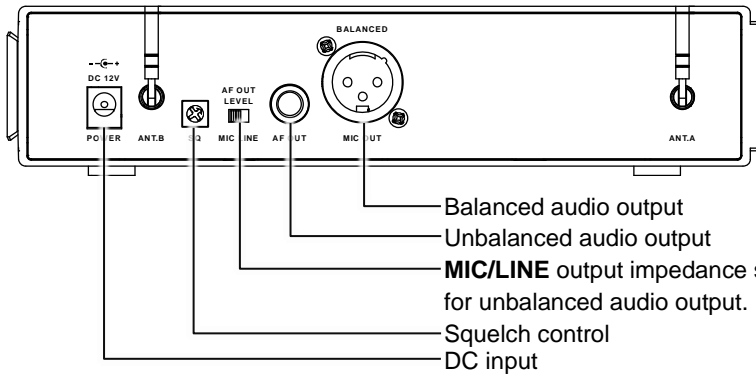
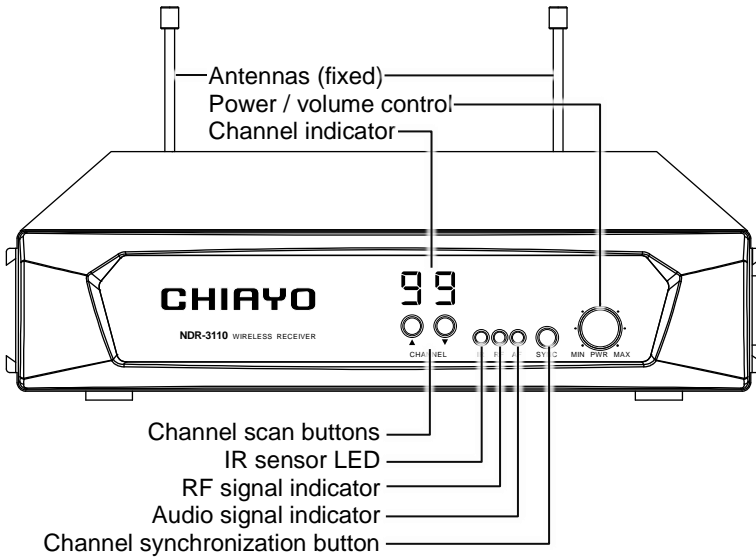

## Adjusting volume level

Volume level can be adjusted by rotating the Power/volume knob.

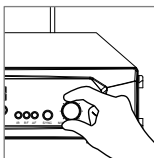

## Scanning & changing channel

First turn on main power switch, the two 7-segment display LED will show last stored frequency. For example, if channel 88 is 630.325MHz, the LED will first display **63**, **03** and **25** in order and return to **88**. Select a channel that corresponds to the transmitter. When transmitter is turned on, either A or B diversity indicator will light up to indicate that it is connected.

For an interference-free operation, a cleaner channel might be necessary if the current one receives too much interference. Before scanning, the transmitter must be switched off. Press **▲** or **▼** and the receiver will scan and stop at the next clean channel.

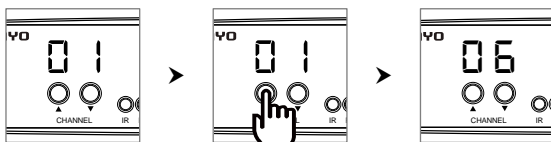

## Channel synchronizing of the receiver and transmitter

Align infrared areas of the receiver and transmitter within 10~30cm. (Fig.1)

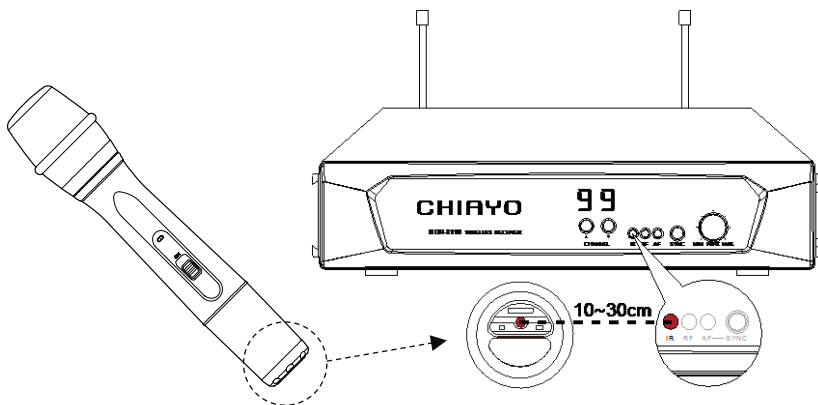
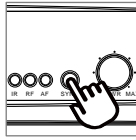

Fig.1

### Changing the receiver's channel

Press the sync button on the receiver. The receiver will transmit the frequency to the transmitter and synchronize the channel.



If it doesn't work check that you have the IR sensor panels aligned, that they are facing each other, devices are within 30cm of each other, and try again.

### Adjusting squelch level

When interference is encountered, try reducing the sensitivity of the receiver by turning the SQ control clockwise, making it less susceptible to interference. If this still does not solve the problem, it means this frequency is not suitable. Adjust the squelch back to where it was and use the scan function to locate a clear channel.

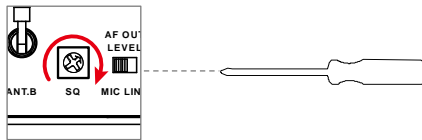

### Audio output connection

- Balanced output:** XLR connector provides balanced audio output signal from this jack to the mixer/amplifier. Use an audio output cable with "XLR" or "Cannon" connector, connect one end to the balanced output jack of the receiver, and the other end to the "MIC IN" jack of the mixer/ amplifier (Fig.2).

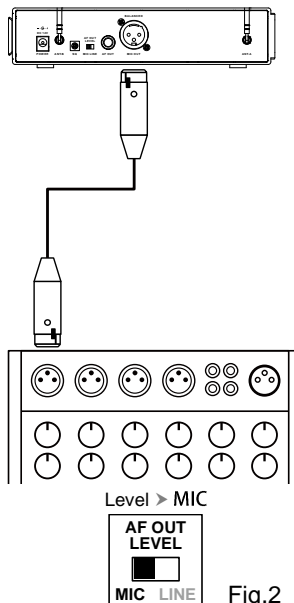

Fig.2

## NDR-3110 UHF 1/2 19" Single-Channel Auto Sync Diversity Receiver

- **Unbalanced output:** ¼" PHONE PLUG connector provides unbalanced audio output signal from this jack to the mixer/amplifier. Use an audio output cable with ¼" PHONE PLUG connectors. Connect one end from the unbalanced output jack of the receiver, and the other end to the "LINE IN" or "MIC IN" jack of the mixer/ amplifier.
- **Level switch setting**
  - When connecting to the **LINE /AUX IN** of a mixer/amplifier, switch to "LINE" position (Fig.3). DO NOT use the "MIC" position as they may not deliver a sufficient high output level
  - When connecting to the "MIC IN" jack of a mixer/amplifier, switch to "MIC" position (Fig.4). Overload distortion may occur at the wrong level position.

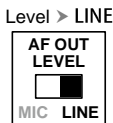
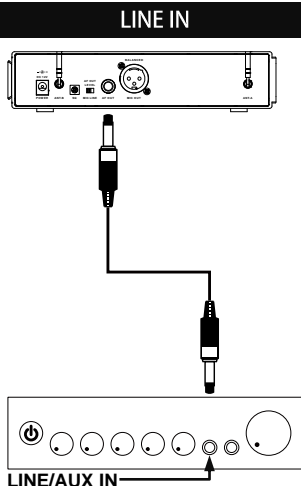

Fig.3

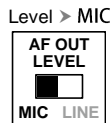
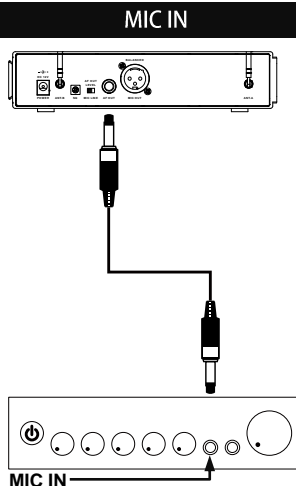
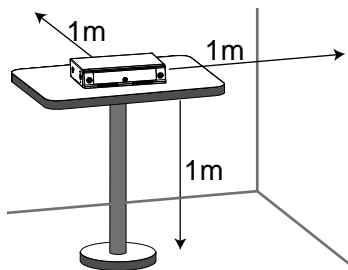

Fig.4

### Receiver installation

1. The receiver should be at least 1m above the ground and 1m away from a wall or metal surface to minimize reflections.
2. The transmitter should also be at least 1m away from a wall or metal surface to minimize reflections.
3. The transmitter should also be at least 1m away from the receiver. Keep antennas away from noise source such as motors, automobiles, neon light as well as large metal objects.
4. Power voltage should not below 12V DC or above 15V DC. Deficient current causes unstable operating voltage or malfunction and over current shortens the product life and possibly damages circuits.



## Rack mounting

The slide rail structure on both sides of the receiver is designed to facilitate the user to connect the two receivers in parallel and quickly install onto the cabinet.

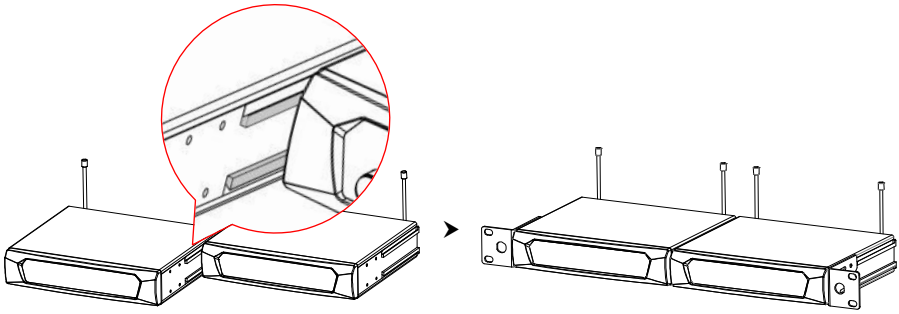

▲  
Rack mount of two receivers

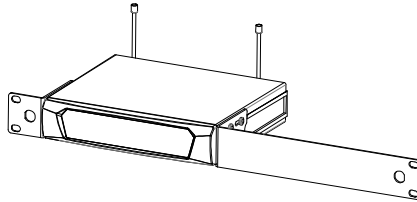

▲  
Rack mount of single receiver

**CHIAYO ELECTRONICS CO., LTD.**

Http://www.chiayo.com.tw | Email: sales@chiayo.com.tw  
Office: 30, Lane 27, Section 4, Jen-Ai Road, Taipei 10685, Taiwan  
Tel: 886-2-27415741 | Fax: 886-2-27525242  
Factory: 88, Chung-Hsiao Street 2, Chiayi 60080, Taiwan  
Tel: 886-5-2711000 | Fax: 886-5-5767611



1211491